

TRUBLUE iQ+ LT / TRUBLUE iQ+ XL AUTO BELAY

Operator Manual

Models: TBIQ+LT / TBIQ+XL



NOTE TO INSTALLERS

Always Read Instructions Before Use

Leave this Operator Manual attached to the Auto Belay. The Operator Manual contains information relating to the safe use of the TRUBLUE iQ+ Auto Belay and includes all product registration and Warranty information. This document may only be removed by the Owner/Operator. Ensure that this Operator Manual is readily available to Operators at all times

Head Rush Technologies TRUBLUE iQ+ Operator Manual
P/N 12603-02

Head Rush Technologies products are covered by a number of patents, including
U.S. Patents 8,490,751; 8,851,235; 9,016,435 and D654,412
& corresponding patents/applications in the USA and in other countries worldwide.





TABLE OF CONTENTS

1.0	SAFETY INFORMATION	6
1.1	Symbols Used in this Manual	6
2.0	WARRANTY CONDITIONS	7
2.1	Customer Responsibility	7
3.0	CERTIFICATION	9
3.1	Standards	9
4.0	DESCRIPTION	10
5.0	SPECIFICATIONS	11
5.1	Battery Specifications	12
6.0	AUTO BELAY PARTS	13
6.1	Label	13
6.2	Location of Safety Labels	14
6.3	Icon Descriptions	15
7.0	UNPACKING	17
7.1	Precautions	17
7.2	Receipt of the Auto Belay	17
7.3	Unpacking the Auto Belay	19
7.4	Storage	20
8.0	INSTALLATION	21
8.1	Precautions	21
8.2	Standards	21
8.2.1	<i>Anchor Points</i>	22
8.2.2	<i>Harness</i>	22
8.2.3	<i>Secondary Connectors</i>	22
8.2.4	<i>Selecting a Location</i>	23
8.2.5	<i>Outdoor Installations</i>	23
8.2.6	<i>Mounting Points</i>	23
8.2.7	<i>Device Orientation</i>	25
9.0	OPERATION	26
9.1	Operator Training	27
9.2	User Instruction	27
9.3	Harness	28
9.4	Carabiner Use	29
9.4.1	<i>Operation</i>	29
9.4.2	<i>Secondary Connections to the Harness</i>	29

9.5	Battery Pack	30
9.5.1	<i>Battery Pack Operation</i>	31
9.5.2	<i>Battery Pack Installation</i>	32
9.5.3	<i>Battery Pack Removal</i>	34
9.5.4	<i>Battery Pack Disposal</i>	35
9.6	Battery Charger	36
9.6.1	<i>Battery Charger Operation</i>	37
9.7	Catch-and-Hold Mode	37
9.7.1	<i>Activating Catch-and-Hold Mode</i>	38
9.7.2	<i>Using Catch-and-Hold Mode</i>	38
9.7.3	<i>De-activating Catch-and-Hold Mode</i>	39
9.7.4	<i>Setting the Preset Hold Time</i>	39
9.7.5	<i>LED Function</i>	40
9.8	Low Battery Mode	41
9.9	Critically Low Battery Mode	41
10.0	INSPECTION & MAINTENANCE	42
10.1	Annual Recertification	42
10.2	Scheduled Maintenance	42
10.2.1	<i>Safety Precautions</i>	43
10.3	Daily Inspection	43
10.4	Weekly Inspection	44
10.4.1	<i>Inspection Procedure</i>	44
10.4.2	<i>Webbing Wear</i>	45
10.5	Six Month Inspection	48
10.5.1	<i>Inspection Procedure</i>	48
10.5.2	<i>Webbing Inspection</i>	48
10.6	Nozzle Replacement	50
10.7	Webbing Line Replacement	51
10.7.1	<i>Safety Precautions</i>	52
10.7.2	<i>Webbing Line Replacement Procedure</i>	52
10.8	Replacement Parts	54
10.9	Troubleshooting	56
10.10	Transportation	57
11.0	MANUFACTURER'S DETAILS	57
12.0	INSPECTION LOGS	58
12.1	Weekly Inspection Log	58
12.2	Six Month Inspection Log	60



IMPORTANT SAFETY NOTICE

Climbing/Descent from Height Is a Dangerous Activity

Read Before Installation & Operation

Failure by the Operator to heed any and all instructions, warnings and cautions for the correct installation, operation, care and maintenance of the TRUBLUE iQ+ Auto Belay may result in death and/or serious injury.

TRUBLUE iQ+ Auto Belay Model TBiQ+LT and Model TBiQ+XL and their associated equipment are designed and specified for use in the recreational climbing/aerial adventure industry as a controlled descent device. Use of the TRUBLUE iQ+ Auto Belay for any purposes other than that intended by the Manufacturer is not permitted.

Owners and Operators of the TRUBLUE iQ+ Auto Belay are responsible for the safety and training of any person using the TRUBLUE iQ+ Auto Belay and are required to undergo training in the correct installation and operation of the device prior to any use.

These instructions must be made readily available to the Operator at all times. Prior to installation and use, all Owners and Operators must have read and shown to have understood all instructions, labels, markings, and safety information pertaining to the installation, operation, care, and maintenance of the TRUBLUE iQ+ Auto Belay system, its component parts, and all associated hardware. Users of the TRUBLUE iQ+ Auto Belay must be trained on proper usage of the Auto Belay. It is the responsibility of the Owner/Operator to provide this training. Failure to do so can result in death, serious injury, and equipment damage.

Health and Safety

Owners and Operators must abide by all Standards, International, Federal, State and Provincial laws, and any specific health and safety regulations pertaining to the installation and use of this product.

Site Rescue Plan

Owners and Operators must have devised an emergency rescue plan for any climber in distress at all sites operating TRUBLUE iQ+ Auto Belay devices. Operators must inform Users of the Auto Belay of the procedure for rescuing a climber in distress prior to climbing.

1.0 SAFETY INFORMATION

1.1 Symbols Used in this Manual

The following safety symbols are used throughout this Manual to highlight potential dangers. One or more precautions may be associated with practices and procedures described within this Manual. Failure to adhere to any precautions highlighted can result in death, serious injury, or equipment damage.

Ensure that you read and understand all safety procedures related to the working environment and the task you are performing.



DANGER

Indicates a hazardous situation exists that, if not avoided, will result in serious injury or death.



WARNING

Indicates a potentially hazardous situation that, if not avoided, could result in serious injury or death.



CAUTION

Indicates a potentially hazardous situation that, if not avoided, may result in injury or equipment damage.



NOTE

Indicates an action that must be taken to ensure personal safety and prevent damage to property or equipment.



CARE FOR THE ENVIRONMENT

Take care to minimize impact on the environment when carrying out this procedure.

2.0 WARRANTY CONDITIONS

The TRUBLUE iQ+ Auto Belay Devices are warranted against factory defects in materials and workmanship (excluding the Battery Pack and specific Field Replaceable Wear Parts - see "Replacement Parts" section below) for a period of two (2) years from the date of purchase. The Battery Pack carries a one (1) year warranty against factory defects in materials and workmanship. This Warranty applies only to the original purchaser, and is contingent upon the Owner/Operator maintaining and using the device in accordance with TRUBLUE iQ+ Auto Belay instructions, including the requirement to continue to maintain annual recertification as described in this Operator Manual. This Warranty is in lieu of all other warranties, express or implied.

The sole remedy for breach of this Warranty, or for any claim in negligence or strict liability in tort, is the repair or replacement of any defective parts by Head Rush Technologies (Manufacturer). Upon notice in writing, Head Rush Technologies will promptly repair or replace all defective items. Head Rush Technologies reserves the right to have any defective equipment returned to its facility, transportation pre-paid, for inspection before making a repair or replacement.

This Warranty is null and void if parts other than genuine parts are used, or if any modifications or services have been performed on the device by anyone other than an authorized Head Rush Technologies servicing agent. This Warranty does not cover any damages resulting from abuse to the device, damage in transit, or any other damage beyond the control of Manufacturer. Head Rush Technologies makes no warranties in respect to trade accessories or component parts which are not made by Head Rush Technologies. Head Rush Technologies expressly excludes from this Warranty the replacement of specific Field Replaceable Wear Parts (see "Replacement Parts" below) which include the Nozzle, the webbing (line) kit, connectors and/or any anchors supplied with the product.

No person, agent or Distributor is authorized to give any Warranty, other than the one herein expressed, on behalf of Head Rush Technologies, or to assume for it any liability pertaining to such products. Head Rush Technologies expressly disclaims any implied guarantee of merchantability, or claim as to whether the device is suited for a particular purpose. Purchaser agrees that Head Rush Technologies shall not be held liable to Owner/Operator for damages of any kind, including but not limited to: lost or projected profits, equipment down time, any losses considered to be caused by non-operation or servicing/recertification down time of the equipment.

2.1 Owner/Operator Responsibility

The following items are considered to be the responsibility of the Owner/Operator and are therefore non-reimbursable under the terms of the Warranty.

- Product installation.
- Normal maintenance, including daily, weekly and bi-annual inspections.
- Normal replacement of service items.

-
- Replacements required because of abuse, misuse or improper operational habits of the Operator.
 - Field replaceable wear parts.
 - Normal deterioration due to use and exposure.
 - The installer and Owner/Operator must fully understand these instructions. Any questions must be submitted in writing to Head Rush Technologies.

Adherence to the Operator Manual, Manufacturer's instructions, and advice given by authorized Head Rush service technicians is the responsibility of the Owner, Installer, and Operator.

3.0 CERTIFICATION

3.1 Standards



NOTE

If the TRUBLUE iQ+ Auto Belay is resold outside of the country of destination, the reseller must provide instructions for use, service, maintenance and repair in the language of the country of use.

The TRUBLUE iQ+ Auto Belay can be used as a climbing/descent system device only in combination with other components. It shall not be deemed suitable for use until it is ensured that the entire system complies with the requirements of appropriate regional, state, and federal directives/standards.

The TRUBLUE iQ+ Auto Belays conform to Regulation (EU) 2016/425 and comply with the following prevailing Safety regulations:

- **AS/NZS 1891:** Industrial fall-arrest systems and devices – Part 3: Fall arrest devices
- **CSA Z259.2.3-99:** Descent Control Devices
- **EN 341: 2011 Class 1A:** Personal protective equipment against falls from a height – Descender devices
- **ANSI/ASSE Z359.4:** Safety Requirements for Assisted-Rescue and Self-Rescue Systems, Subsystems and Components.
- **EN 360:2002:** Personal protective equipment against falls from a height - Retractable type fall arresters
 - **Section 4.5:** Maximum force <6kN for 150kg capacity
- **EN/IEC 62368-1:2020:** Safety of Electronic Equipment within the field of audio/video, information technology, and communication technology

EU Declaration of Conformity:

EU Declaration of Conformity can be downloaded at this website address:

www.headrushtech.com/certification-documents

Body controlling the manufacture of this PPE:

TÜV SÜD Product Service GmbH
Ridlerstraße 65
80339 München, Germany

Notified body performing the CE type exam:

TÜV SÜD Product Service GmbH
Ridlerstraße 65
80339 München, Germany

4.0 DESCRIPTION

The TRUBLUE iQ+ Auto Belay is a controlled descent device designed specifically for use in the climbing/aerial adventure industry. The TBiQ+LT offers a maximum descent height of 12.5 m (41 ft), and the TBiQ+XL offers a maximum descent height of 20 m (65.6 ft). TRUBLUE iQ+ Auto Belays are suitable for user weights ranging from 10 - 140 kg (22 - 309 lbs).

The design of the TRUBLUE iQ+ Auto Belay permits simple installation and removal and incorporates an advanced self-regulating magnetic brake system and automatic line retraction. The patented magnetic braking mechanism offers users a smooth descent with a minimal variation in descent rate of both children and adults. There are no wearing parts in the magnetic brake mechanism, ensuring that reliability remains high while maintenance and operating costs are kept to a minimum.

The TRUBLUE iQ+ Auto Belay also offers a secondary friction brake system that, when activated, catches and holds a user in position so that rest can be taken during climbing. The secondary friction brake is controlled by buttons that are located at the bottom and top of the climbing route and is powered by a rechargeable Li-Ion battery. The secondary friction brake system is independent from the patented magnetic brake system. The patented magnetic brake system is the primary braking system and cannot be disconnected.

To protect the longevity of the TRUBLUE iQ+ Auto Belay, installation, care, and use of the TRUBLUE iQ+ Auto Belay must be carried out in accordance with the instructions in this Manual. The theoretical lifespan of the TRUBLUE iQ+ Auto Belay is unlimited with proper care and performing the required annual service maintenance. For planning purposes, we recommend a planned lifespan of 15 years.

5.0 SPECIFICATIONS

MODELS	TBiQ+LT (12.5m) TBiQ+XL (20m)		
CERTIFICATION	IN ACCORDANCE WITH EN 341:2011-1A AND EN 360:2002		
DIMENSIONS	292 x 369 x 265 mm (11.5 x 14.5 x 10.5 in)		
NET WEIGHT	TBiQ+LT: 19.2kg (42.3lbs) TBiQ+XL: 22.0kg (48.5lbs)		
MATERIALS	CASING	Aluminum Alloy	
	INTERNAL PARTS	Zinc plated steel	
	NOZZLE	Polypropylene	
	NOZZLE INSERT	304 Stainless Steel	
	WEBBING	Polyamide/UHMWPE	
	MODEL	MINIMUM	MAXIMUM
MOUNTING HEIGHT (NOZZLE TO GROUND)	TBiQ+LT (12.5m)	4.5m (14.8 ft)	12.5m (41.0 ft)
	TBiQ+XL (20m)	12.0m (39.4 ft)	20.0m (65.6 ft)
USER WEIGHT	ALL MODELS	10 kg (22 lbs)	140kg (309 lbs)
AUTO BELAY OPERATING TEMPERATURE	ALL MODELS	-4° C (25° F)	60° C (140° F)
	ALL MODELS (DRY)	-10° C (14° F)	60° C (140° F)
AUTO BELAY STORAGE TEMPERATURE	ALL MODELS	-20° C (-4° F)	60° C (140° F)
LANDING VELOCITY	ALL MODELS	-----	2.0 m/s (6.5 ft/s)



METRIC UNITS ARE THE CONTROLLING UNITS OF MEASURE IN THIS MANUAL. IMPERIAL UNITS ARE PROVIDED AS A COURTESY AND HAVE BEEN ROUNDED. IF THE OWNER/OPERATOR/INSTALLER MUST MAKE ANY UNIT CONVERSIONS, THE METRIC UNITS SHOULD BE REFERENCED.

5.1 Battery Specifications

	MODEL	SPECIFICATION
BATTERY VOLTAGE	ALL MODELS	18V
BATTERY CAPACITY	ALL MODELS	2.2 Ah/39.6 Wh
BATTERY OPERATING TEMPERATURE	ALL MODELS	-20° C to 58° C (-4° F to 136° F)
BATTERY STORAGE TEMPERATURE	ALL MODELS	Less than 26° C (80° F)
BATTERY CHARGING TEMPERATURE	ALL MODELS	0° C to 45° C (32° F to 113° F)
BATTERY CHARGING TIME	ALL MODELS	5 hours to 95% charge, 8 hours to 100% charge



NOTE

The Battery Operating Temperature limits are different than the Auto Belay Operating Temperature limits.

6.0 AUTO BELAY PARTS

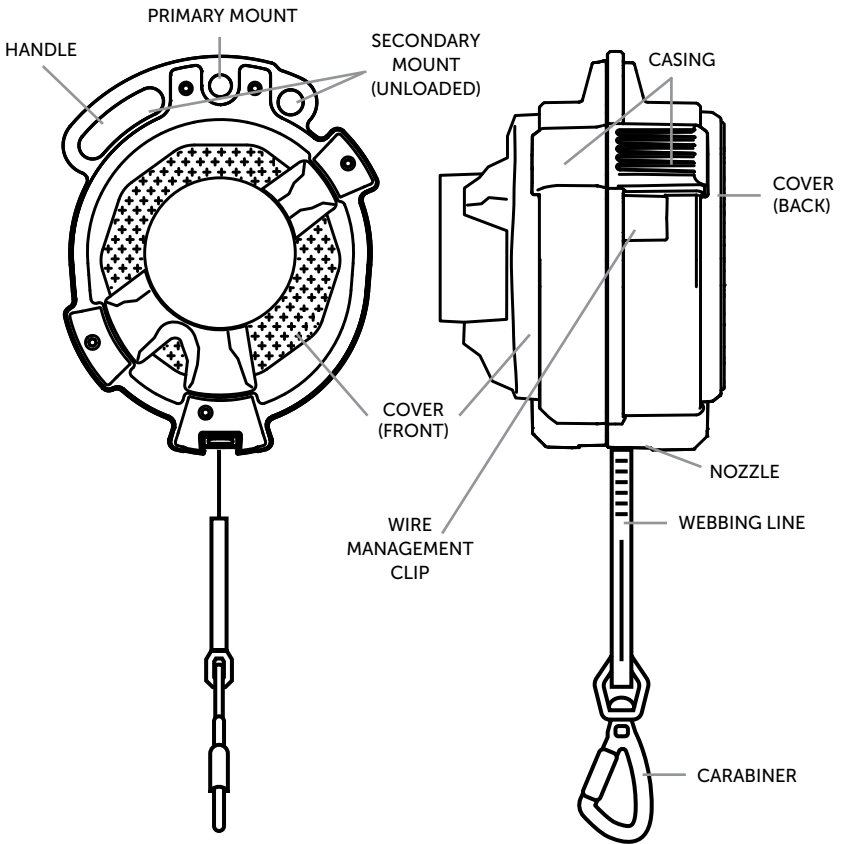

6.1 Label

TBiQ+XX **SN iQP#####**

 Model number Unit serial number
SN iQXLP####

CE 0123

Notified body
for CE type
examination

IN ACCORDANCE WITH EN 341:2011-1A
AND EN 360:2002





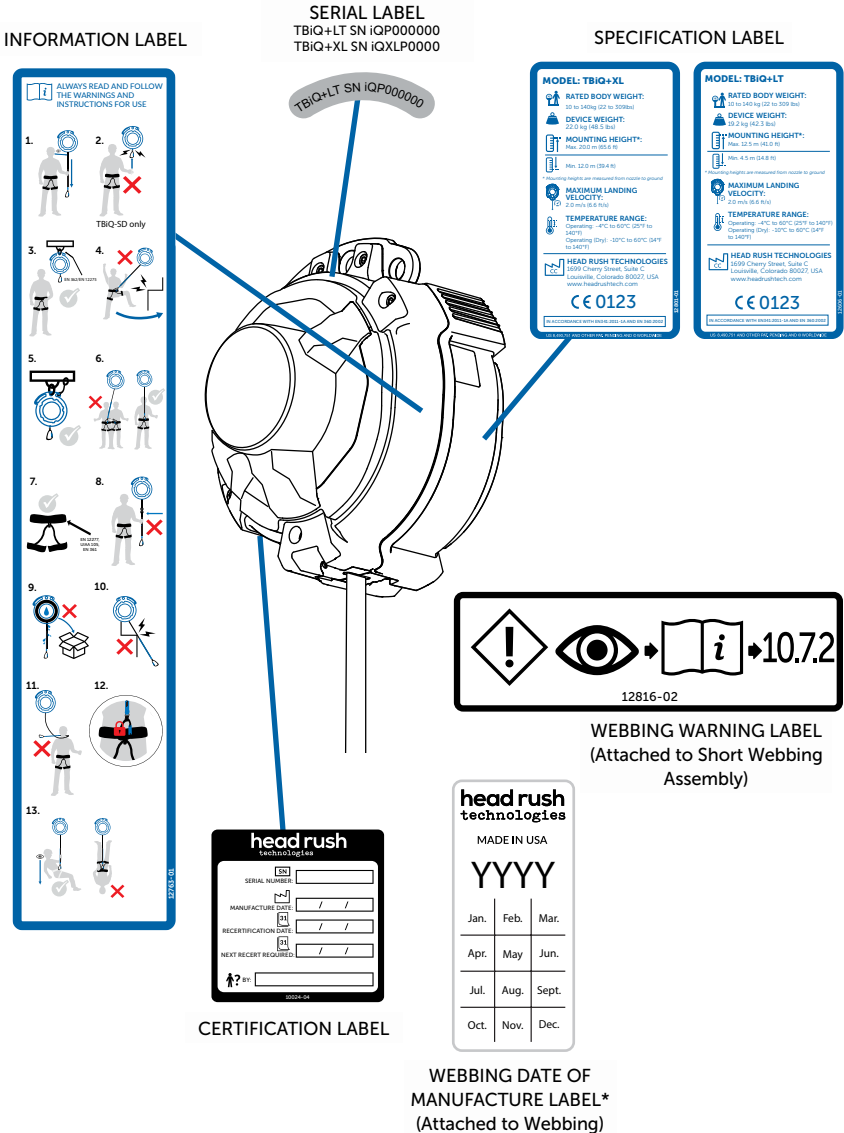



EN standard and
device classification

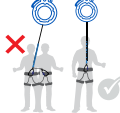

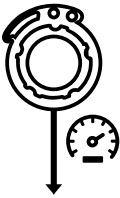
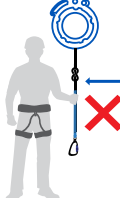

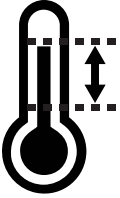
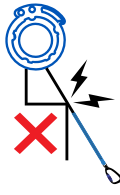
6.2 Location of Safety Labels

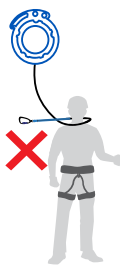

*The date of manufacture for the webbing assembly must be recorded in the inspection log in the back of this Operator Manual. 12.5m or 20.0m webbing assemblies should be replaced every 1.5 years regardless of condition.

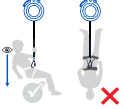
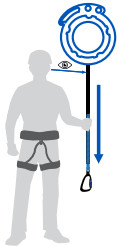
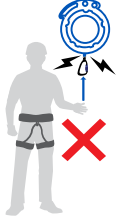
6.3 Icon Descriptions

	<p>Device Weight</p>		<p>Only one user at a time</p>
	<p>Body Weight</p>		<p>Harness standards</p>
	<p>Landing Velocity</p>		<p>Do not alter the line. Do not clamp, knot or tie on additional line</p>
	<p>Country of Manufacture</p>		<p>Do not store the line inside the device wet</p>
	<p>Temperature Range</p>		<p>Never install the device where the line passes over sharp edges, high friction areas</p>
	<p>Minimum Height</p>		<p>Never permit line to wrap around or become entangled with neck, arms, or legs</p>
	<p>Maximum Height</p>	 <p>Only compatible with TRUBLUE iQ+ webbing</p>	

	Check descent path is clear, Always land with slightly bent knees to absorb landing
	Inspect the webbing daily Check retraction before each use
	Do not let TBIQ-SD (The TRUBLUE iQ Speed only) retract uncontrolled
	Minimum connector strength for installation
	Avoid swing falls into objects
	Primary connector taut, secondary back-up connector loose
	Connect the carabiner to the designated belay loop of your harness, making sure the gate is locked

	Refer to the Manual
	Examine/Check
	Connector Polarity
	Serial number
	Manufacture Date
	Date
	Technician
	Volts
	Amps

7.0 UNPACKING

7.1 Precautions



LEAVE THIS OPERATOR MANUAL ATTACHED TO THE AUTO BELAY UNTIL INSTALLATION IS COMPLETE

The Operator Manual contains information relating to the safe use of the TRUBLUE iQ+ Auto Belay and includes all product registration and Warranty information. The Operator Manual document may only be removed by the Owner/Operator. Ensure this Manual is readily available to Auto Belay Owner/Operators at all times.



DO NOT DISPOSE OF PACKAGING

The main cardboard box and internal packaging are required for the return of the Auto Belay for the annual recertification. Please keep packaging in a safe place until required.

7.2 Receipt of the Auto Belay

The TRUBLUE iQ+ Auto Belay is packaged in a recycled cardboard box and contains:

- 1 x TRUBLUE iQ+ Auto Belay Model TBiQ+LT or TRUBLUE iQ+ Auto Belay Model TBiQ+XL
- 1 x 12.5 m (41 ft) or 20m (65.6ft) webbing lower line
- 1 x Carabiner or EN 362 connector attached to the Webbing Lower Line. Some variants do not come with a connector
- 1 x Summit Button
- 1 x Base Button
- 1 x Operator Manual
- 2 x 20m Communication Cable
- 1 x Y – Cable Splitter
- 1 x Li-Ion Battery Pack
- 1 x Battery Charger
- 1 x Catch and Hold Hardware Pack
- 1 x Installation Guide



TBIQ+ Auto Belay with Webbing



TBIQ+ Summit Button



TBIQ+ Base Button



20 m Communication Cable



Y-Cable Splitter



*Li-Ion Battery Pack
(Ships inside of the Base Button)*



Battery Charger

7.3 Unpacking the Auto Belay

To unpack the Auto Belay:

1. Upon receipt of the Auto Belay, inspect for signs of shipping damage or contamination. If the Auto Belay shows any signs of damage or mishandling contact your Head Rush Technologies distributor.
2. Check that all labels affixed to the Auto Belay are present and legible.



Do not use the Auto Belay after date shown here.

3. Check the Certification Label for the 'Next Recertification Required' date. If the date shown has passed or the label is missing or illegible, the Auto Belay must not be put into service.
4. Register your Auto Belay online at www.headrushtech.com/register.



PRODUCT REGISTRATION MUST BE COMPLETED

Product Registration is critical for receiving product notifications, recertification notices, and up-to-date information for the safe use of the TRUBLUE iQ+ Auto Belay. Registration is fast and easy and can be done online at www.headrushtech.com/register.

5. Read the Operator Manual and familiarize yourself with all aspects of installation, operation, care and maintenance.

7.4 Storage

If the Auto Belay is to be left unused for longer than two weeks, ensure the unit is clean and dry and line is fully retracted into the unit.

When returning the Auto Belay to duty after an extended period of inactivity, always carry out a full inspection and operational check.

For Battery Pack storage longer than 30 days, Head Rush Technologies suggests the following

- Store the Battery Pack where the temperature is below 80°F (26°C) and away from moisture.
- Store Battery Packs in a 30%-50% charged condition.
- Every six months of storage, charge the Battery Pack as normal.



DO NOT STORE IN WET CONDITION

After exposure to water or damp conditions thoroughly clean and dry the Auto Belay. Ensure Auto Belay is not left with wet webbing line retracted inside the casing for long periods (longer than 1 week). If the webbing is wet and the device is to be stored, remove the Nozzle and pull all the webbing out until the shackle is exposed. Insert a pin through the line to prevent retraction, and allow the webbing to dry naturally away from open fire or heat source.

Always store in a clean and dry environment.

8.0 INSTALLATION

Refer to the included Installation Guide for detailed installation instructions.

8.1 Precautions



ALWAYS USE DESIGNATED MOUNTING POINTS

Never install the Auto Belay using any part of the device apart from the designated mounting points. Incorrect mounting can result in serious injury or death.



ALWAYS USE THE CORRECT MOUNTING HEIGHT

Failure to install the device at the correct mounting height could result in damage to the device or loss in device performance.



HARD IMPACTS MAY RESULT IN STRUCTURAL DAMAGE

Dropping of, or hard impacts to, the Auto Belay can result in serious damage to mounting points and internal parts and may compromise safety of operation. If the Auto Belay is subject to a hard impact, remove it from duty and return to a service agent for inspection.



HEAVY ITEM - TBIQ+LT: 19.2KG (42.3LBS) TBIQ+XL: 22.0KG (48.5LBS)

Take care when lifting the Auto Belay. Take care not to drop the device as this may result in serious injury or equipment damage.



ALWAYS MOUNT VERTICALLY

Always mount the Auto Belay vertically with the Nozzle pointing downwards and the line exiting the bottom of the device. Failure to do so will result in incorrect operation and compromise User safety.



HARMFUL CONTACT

Do not allow solvents, acids, sharp edges etc. to get into contact with the device, especially the webbing. If this occurs, the Auto Belay must be inspected.

8.2 Standards

Prior to installation, all Operators must be familiar with the requirements of all relevant Standards for anchor points, hardware, and equipment used with the Auto Belay.

8.2.1 ANCHOR POINTS

All anchor points and connectors used with a TRUBLUE iQ+ Auto Belay must conform to any federal or state requirements for such devices.

Head Rush Technologies requires anchor points to have a minimum load capacity of 10 kN (2200 lbs) in expected directions of application. Other national and international standards for anchor points may apply and require higher load capacity. Consult with the authority having jurisdiction for your required load capacity.

The location and anchor points for the TRUBLUE iQ+ Auto Belay should comply with the following:

- Anchor points are not to be used by additional devices or as attachments for hardware not associated with the Auto Belay installation.
- Anchor points should be of a suitable size to correctly install any mounting hardware.

8.2.2 HARNESS

All harnesses used in conjunction with the TRUBLUE iQ+ Auto Belay must be of the correct size and fit, be in serviceable condition, and comply with one of the following standards:

- EN 361 - Personal protective equipment for prevention of falls from a height – Full body harness.
- EN 813 - Personal protective equipment for prevention of falls from a height – Sit harness.
- EN 12277 - Type A. Full Body Harness.
- EN 12277 - Type B. Small Full Body Harness.
- EN 12277 - Type C Sit Harness.

8.2.3 SECONDARY CONNECTORS

All secondary connectors and hardware used in the installation of the TRUBLUE iQ+ Auto Belay must conform to the requirements of:

- EN 362 - Types of connectors for personal protection.
- EN 12275 - Types of connectors for mountaineering.

All connectors, hooks, D-rings and shackles used to mount the TRUBLUE iQ+ Auto Belay must be of compatible size, shape and strength for the mounting point to which they are attached.

8.2.4 SELECTING A LOCATION

The TRUBLUE iQ+ Auto Belay is to be mounted at the top of the climbing route/descent path with the Nozzle and webbing line pointed down.

When selecting a location to mount the Auto Belay, ensure that:

- The Auto Belay will hang vertically over the climbing route with the Nozzle pointing down.
- All paths that can be encountered by the User when connected to the Auto Belay are free of sharp edges and high-friction surfaces that may damage the webbing line.
- Ensure that the descent path and landing area are free of other people or obstacles that may cause entanglement or restrict the user's ascent or descent.
- The Auto Belay is free to pivot in all directions and should not bind the mountings or be able to impact upon the surrounding structure.

8.2.5 OUTDOOR INSTALLATIONS

The TRUBLUE iQ+ Auto Belay may be installed outdoors.

It is recommended that in wet or high-variable temperature environments, the Auto Belay is protected from the direct ingress of water or foreign objects. It is recommended to remove the Battery Pack for long periods of rain.



NOTE

Prolonged exposure to the elements will increase the risk of internal corrosion and degradation of the webbing line, resulting in increased operation and servicing costs. Increased inspections are required in these types of environments.

Outdoor installations in high UV, wind, and sand will require more frequent webbing replacements as these elements will artificially age the webbing and reduce its strength over time. Head Rush Technologies recommends storing the webbing inside the device when not in use and replacing the webbing every 6 months as a precaution.

8.2.6 MOUNTING POINTS



USE ONLY THE DESIGNATED MOUNTING POINTS

Use only the correct mounting points. Use of incorrect points can result in equipment damage.

Ensure all mounting hardware is secure but free to pivot in mounting point.

Ensure the mounting insert is used with the connector to reduce wear on the mounting point.

The TRUBLUE iQ+ Auto Belay is manufactured with a single central pivot mounting point, an offset mounting point, and a formed handle located at the top of the casing. These mounting points are located to ensure the unit hangs centrally and vertically with the line Nozzle pointing down.

The Rear Cover is a sacrificial protective cover designed to prevent damage to both the device and any adjacent surface. Should the Cover become excessively worn, damaged, or aesthetically unpleasing, it may be replaced by the Owner/ Operator. Details of replacement parts may be found in the Replacement Parts section of this Manual.

The TRUBLUE iQ+ Auto Belay **MUST** be installed with the flat plastic cover facing the climbing/descent wall. The TRUBLUE iQ+ Brake Module **MUST** face away from the climbing/descent wall. The flat plastic cover has been designed specifically to be more durable for impacts with the climbing/descent wall surface caused by natural movements of the Auto Belay while users are attached to the Auto Belay.

Install the Auto Belay by using the central mounting point, as shown below, with a longer, non-loaded secondary mount utilizing the offset mount or handle mounting points. Only use the central mounting point as shown. Ensure mounting hardware is secure and the unit is free to pivot in all directions.

The TRUBLUE iQ+ Auto Belay has a plastic mounting insert which is inserted through the primary mount attachment point. The mounting connector or carabiner should always be used with the plastic mounting insert during installation. This plastic mounting insert is designed to protect the aluminum mounting point from deformation due to swinging and movement of the Auto Belay during use. If your mounting insert becomes broken or lost, replacement mounting inserts are available from Head Rush Technologies.

Other mounting options are available. Contact Head Rush Technologies for more information.

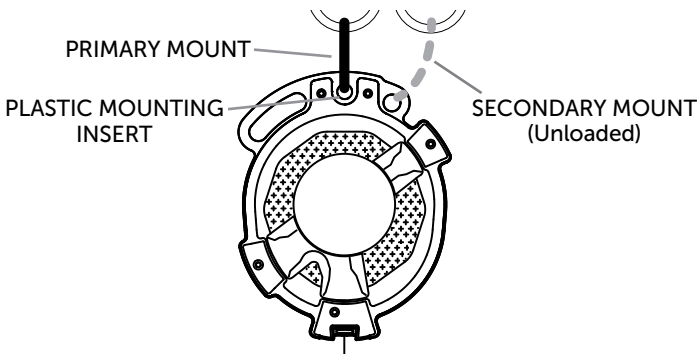

8.2.7 DEVICE ORIENTATION

Always mount the Auto Belay with the covers parallel to the face of the climbing wall. Mounting in this direction will allow the Auto Belay to swing laterally and minimize the wear on the webbing line, Nozzle assembly and mounting points. The flat cover **MUST** be mounted facing the climbing/descent wall. The Brake Module **MUST** be facing away from the climbing/descent wall.

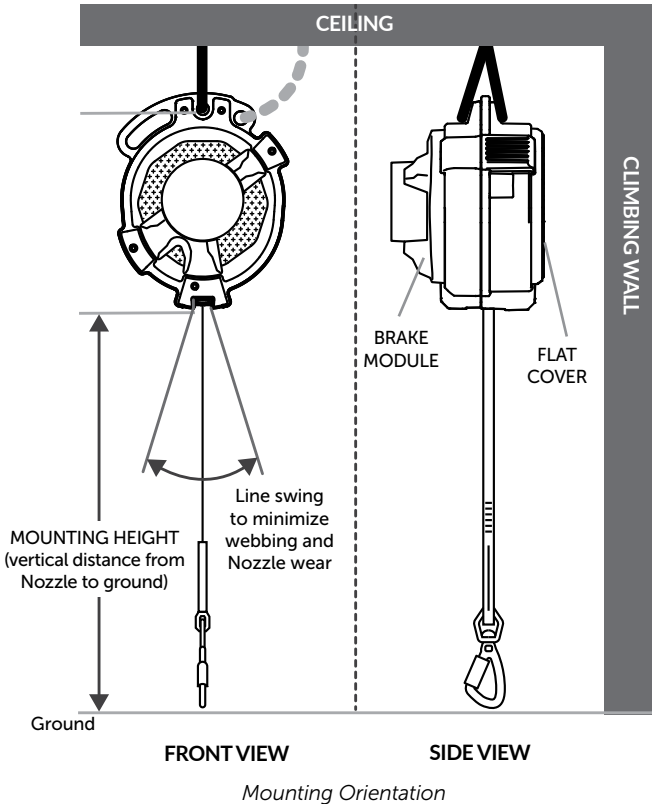

9.0 OPERATION

Owner/Operators of the TRUBLUE iQ+ Auto Belay are responsible for the safety and training of any person using this equipment and owners are required by the Manufacturer to read, understand and follow all instructions in this Operator Manual regarding the correct installation and operation of the Auto Belay prior to any use.



UNSAFE OPERATION

Remove the Auto Belay from service immediately if there is any concern over its correct operation or for user safety.

Do not return the Auto Belay to service until it has been inspected and completed a recertification inspection and test by an approved Head Rush Technologies Service Agent.



EMERGENCY RESPONSE PLAN

Owners and Operators must have devised an emergency rescue plan for any user in distress at all sites operating TRUBLUE iQ+ Auto Belay Devices. Operators must inform users of the Auto Belay of the procedure for rescuing a user in distress prior to use.



STOP USE IMMEDIATELY IF ANY OF THE FOLLOWING OCCUR:

- Excessively fast webbing wear is noticed. Check unit mounting and replace webbing. Place the device back in service and check that fast webbing wear is resolved.
- The descent speed increases from its normal level. Wait for the device to cool down. Place the device back in service and check if descent speed has returned to its normal level.
- The device stops retracting webbing. Send the unit in for service.



ITEMS PREVENTING RETRACTION

Any device that fails to retract or keep pace with the user must be removed immediately from service and diagnosed by the Owner/Operator. If items external to the device (see below for examples) are responsible for retraction problems, these must be corrected before placing the TRUBLUE iQ+ Auto Belay back into service. If items external to the device have been removed, and retraction problems persist, contact the nearest authorized Head Rush Technologies service center.

Examples of external items that could prevent or affect retraction of a TRUBLUE iQ+ Auto Belay:

- Foreign objects becoming lodged in the Nozzle.
- Route marking tape interfering with the webbing and/or becoming lodged in the Nozzle.
- Protruding handholds, climbing wall features or climbing equipment interfering with webbing retraction.

9.1 Operator Training

All personnel involved in the operation of the Auto Belay must be trained and deemed competent in the following aspects of TRUBLUE iQ+ Auto Belay operation:

- Transportation and storage.
- Installation, use of attachment points, attachment methods and hardware.
- Inspection, cleaning, and scheduled servicing of the Auto Belay, its component parts and associated attachment hardware.
- All requirements of participant training.
- Daily webbing inspection and replacement.
- Battery Pack Safety and Inspection
- Battery Charger Use and Safety
- Operation of Catch-and-Hold Technology

9.2 User Instruction



NEVER USE WITHOUT BEING CORRECTLY ATTACHED

Ensure the connector is attached to the belay loop of the harness or other approved anchor point and the latch is fully closed and the gate engaged before using. A gate check must be performed after every connection.

Failure to do so can result in serious injury or death.



WARNING

Climbing is considered a strenuous activity. If you have any physical or medical conditions that may affect your climbing ability consult a medical professional prior to participation.



POTENTIAL FOR PARTICIPANT ENTANGLEMENT

Potential for participant entanglement exists during descent. Ensure all loose items that may become tangled are tightened or removed before using the Auto Belay. A risk assessment should be completed at the installation site to determine the necessary PPE for users, such as type and brand of harness, use of helmets, etc.

Prior to clipping in, all users must be instructed in the safe use of the Auto Belay. Operators are to ensure all users are familiar with the site rescue plan in the event the user becomes distressed.

Prior to using, the user must be trained by the Owner/Operator and completely understand the following precautions:

- Check the Auto Belay operation by pulling out a short section of webbing line and allowing it to retract.
 - If the Auto Belay line fails to retract, do not clip into the Auto Belay and request assistance.
 - If the Auto Belay stops retracting for any reason while attached, STOP CLIMBING. If there is little to no slack in the line, apply your bodyweight onto the webbing and the Auto Belay will descend. Notify the Operator immediately.
- Check the harness is correctly fitted and tightened.
- Check the connector from the Auto Belay line is connected to the designated loop on the harness and the gate is properly closed.
- Ensure the carabiner gate is facing away from the user.
- Never start descent from above the Auto Belay.
- Prior to descent, ensure descent path and landing area are free of people and obstructions.
- Avoid swinging while descending.
- Always descend feet first using feet to fend off obstacles and prepare for landing.
- After using, reattach the connector to an appropriate connection point at the bottom of the wall.

9.3 Harness



USE AN APPROVED HARNESS

Always use a harness complying with the standards specified in this Manual.

Ensure the harness is appropriate for use, in a serviceable condition and correctly fitted. Always follow the harness Manufacturer's instructions for fit, care and use.

9.4 Carabiner Use

On some models, a triple locking self closing carabiner is supplied as an integral part of the descent line. The carabiner must be checked and be in serviceable condition before any use. Ensure the carabiner is only loaded along its vertical direction.



NOTE

If the integral carabiner is damaged or unserviceable, the complete descent line must be replaced. Use only genuine TRUBLUE iQ+ replacement parts.

9.4.1 OPERATION

Triple locking carabiners are opened by sliding the gate down, rotating the gate's collar and pushing the gate open towards the spine of the carabiner.

- Attach the carabiner to the correct loop on the harness with the gate facing away from the user.
- Allow the gate to snap shut, ensuring the collar has rotating back and is locked. Ensure that no clothing, webbing or other objects are obstructing the gate.
- Double check that the gate is secure.



Step 1 – Slide



Step 2 - Twist



Step 3 – Depress

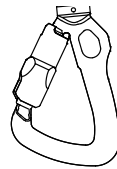

Step 4 – Release

Carabiner Operation

The connector must be inspected and operated in accordance with the connectors Operator Manual. Other connectors are available and should be operated in accordance with their individual manuals.

9.4.2 SECONDARY CONNECTIONS TO THE HARNESS

A secondary connector may be used with the TRUBLUE iQ+. It is the responsibility of the Operator to determine if a secondary connector is required for use. Head Rush Technologies offers several options for secondary connectors, or continuous connection systems.

9.5 Battery Pack



WARNINGS

Do not crush, drop, or damage the Battery Pack. Do not use a Battery Pack that has been dropped or received a sharp blow. Batteries can explode in the presence of a source of ignition. Never place the Battery Pack near an open flame or heat source. An exploded Battery Pack can propel debris and chemicals. If exposed, flush with water immediately.

Under extreme usage or temperature conditions, battery leakage may occur. If liquid comes in contact with your skin, wash immediately with soap and water, then neutralize with lemon juice or vinegar. If liquid gets into your eyes, flush them with clean water for at least 10 minutes, then seek immediate medical attention.

Do not attempt to destroy or disassemble the Battery Pack or remove any of its components. Lithium-ion batteries must be recycled or disposed of properly. Never touch both terminals with metal objects and/or body parts as short circuit may result. Keep away from children.

Failure to comply with these warnings could result in fire and/or serious injury.



CAUTIONS

Only charge the TRUBLUE iQ+ Battery Pack with the Head Rush Technologies supplied TRUBLUE iQ+ Battery Charger. Attempts to charge the Battery Pack with unapproved chargers may result in damage to the Battery Pack, fire, or serious injury.

Do not attempt to power any device other than the TRUBLUE iQ+ with the supplied Battery Pack.

Do not submerge the Battery Pack in water.

Do not charge the Battery Pack in a damp or wet location.

Do not store the Battery Pack in direct sunlight or in a vehicle.



NOTES

Save these instructions. Refer to them frequently and use them to instruct others who may use the TRUBLUE iQ+.

For best results, the Battery Pack should be charged in a location where the temperature is more than 50°F (10°C) but less than 100°F (37.8°C).

The TRUBLUE iQ+ Auto Belay uses a Head Rush Technologies supplied 18 V rechargeable lithium-ion Battery Pack to power all sensing, LED, and Catch-and-Hold Technology. The Battery Pack is NOT required for normal Auto Belay braking during descent. If the Battery Pack is removed or runs out of charge, the TRUBLUE iQ+ Auto Belay will function just like a regular TRUBLUE iQ Auto Belay and is safe for use. The Battery Pack must be recharged periodically for continued operation of the Catch-and-Hold Technology. The Battery Pack should be inspected for damage at every charge interval. Head Rush Technologies recommends re-charging the Battery Pack every night to ensure a full day worth of operation. It is safe to leave the Battery Pack plugged into the Battery Charger overnight.

Battery Protection Features:

- Head Rush Technologies Battery Packs are designed with features that protect the lithium-ion cells and maximize battery life.

9.5.1 BATTERY PACK OPERATION

Charging the Battery Pack

The Battery Pack is shipped in a low charge condition to prevent possible problems. Therefore, you will need to charge the Battery Pack with the supplied Battery Charger before installing in the TRUBLUE iQ+ Auto Belay. Charge the Battery Pack until the LED on the Battery Charger turns green.

Charge Time: 5 hours for 95% charge, 8 hours for 100% charge

Charging a Cool Battery Pack

If the Battery Charger does not charge the Battery Pack under normal circumstances, contact Head Rush Technologies for a replacement.

Charge only with the Head Rush Technologies supplied TRUBLUE iQ+ Battery Charger.

Make sure the power supply is normal household voltage

- 120 V/240 V, AC Only, 50-60 Hz

Make sure the Battery Pack connector is fully inserted into the Battery Charger connector.

Connect the Battery Charger to the power supply.



NOTE

The LED on the Battery Charger will turn Red to indicate that the Battery Pack is charging.

When charging is complete, the LED on the Battery Charger will turn Green.

The Battery Pack will become slightly warm to the touch while charging. This is normal and does not indicate a problem.

Do not place the Battery Charger or the Battery Pack in an area of extreme heat or cold.



NOTE

The Battery Charger and Battery Pack should be placed in a location where the temperature is more than 50°F (10°C) but less than 100°F (37.8°C).

When the Battery Pack is fully charged, unplug the Battery Charger from the power supply, then unplug the Battery Pack from the Battery Charger.

Charging a Hot Battery Pack

Under continuous use, the Battery Pack may become hot. Let a hot Battery Pack cool down for approximately 30 minutes before attempting to charge.

Once the Battery Pack is cool, refer to the section “Charging a Cool Battery Pack” for charging instructions.

Batteries

The TRUBLUE iQ+ Battery Pack has been designed to provide maximum trouble-free life. However, like all batteries, they will eventually wear out. Do not disassemble the Battery Pack or attempt to replace the batteries.

9.5.2 BATTERY PACK INSTALLATION

The Battery Pack is located in the Battery Tray and is accessible using the Battery Removal Tool. An attempt to remove the Battery Pack using any other object may result in damage to the Battery Pack or the Base Button.

Instructions:

- Insert Battery Removal Tool into the slots on the front of the Base Button



- Press in until the Battery Tray slides out of the Base Button



NOTE

An empty Battery Tray may not slide out fully on its own. Pull down lightly on the Battery Tray to slide out fully.

- Install the Battery Pack in the Battery Tray and connect the Battery Pack wire to the Tail Assembly wire.



- Slide the Battery Tray back into the Base Button until it clicks into place

9.5.3 BATTERY PACK REMOVAL

The Battery Pack is located in the Battery Tray and is accessible using the Battery Removal Tool. An attempt to remove the Battery Pack using any other object may result in damage to the Battery Pack or the Tail Assembly.

Instructions:

- Insert Battery Removal Tool into the slots on the front of the Base Button



- Press in until the Battery Tray slides out of the Base Button



- Remove the Battery Pack and disconnect the Battery Pack wire from the Base Button wire.



9.5.4 BATTERY PACK DISPOSAL

The Battery for this product has been designed to provide maximum life. However, like all batteries, it will eventually wear out. Do not disassemble the Battery Pack and attempt to replace any Battery components.



CARE FOR THE ENVIRONMENT

To preserve natural resources, please recycle batteries properly. This product uses lithium-ion batteries. Local, State, or Federal laws may prohibit disposal of batteries in ordinary trash. Consult your local waste authority for information regarding available recycling and/or disposal options.

9.6 Battery Charger



WARNINGS

Only charge the TRUBLUE iQ+ Battery Pack with the TRUBLUE iQ+ Battery Charger. Attempts to charge other types of batteries may cause the batteries to burst, causing damage or personal injury.

Do not attempt to modify the Battery Charger or create accessories not recommended for use with the Battery Charger. Any alteration or modification is misuse and could result in a hazardous condition leading to possible serious personal injury.

Do not use the Battery Charger outdoors or expose to wet or damp conditions. Water entering the Battery Charger will increase the risk of electric shock.

Do not operate the Battery Charger with a damaged cord or plug.



CAUTIONS

Do not attempt to use the Battery Charger as a power supply for any device.

Use of an attachment not recommended or sold by Head Rush Technologies may result in a risk of fire, electrical shock, or injury.

Ensure cord is located so that it will not be stepped on, tripped over, come in contact with sharp edges or moving parts, or otherwise subjected to damage or stress. This will reduce the risk of accidental falls, which could cause injury and damage to the cord.

Keep cord and Battery Charger away from heat to prevent damage to the housing or internal parts.

An extension cord should not be used unless absolutely necessary. Use of an improper extension cord could result in a risk of fire and electric shock. If an extension cord must be used, ensure the following:

- That the pins on the plug of the extension cord are the same number, size and shape as those on the Battery Charger
- That the extension cord is properly wired and in good electrical condition

Do not operate the Battery Charger if it has received a sharp blow, been dropped, or otherwise damaged in any way.

Do not disassemble the Battery Charger.

Unplug the Battery Charger from the outlet before attempting any maintenance or cleaning.

Do not insert any foreign item into the connector end of the Battery Charger.



NOTES

Disconnect the Battery Charger from the power supply when not in use.

If any parts are damaged or missing, do not operate the Battery Charger until the parts are replaced.

Save these instructions. Refer to them frequently and use them to instruct others who may use the TRUBLUE iQ+.

The TRUBLUE iQ+ Auto Belay ships with a Battery Charger that has been tailored to the TRUBLUE iQ+ Battery Pack for optimal life expectancy. Included with the Battery Charger are plug options for various countries.

9.6.1 BATTERY CHARGER OPERATION



NOTE

If at any point during the charging process the LED is not lit, disconnect the Battery Pack from the Battery Charger to prevent damage to the Battery Pack. Disconnect the Battery Charger from the power supply. **DO NOT** connect another Battery Pack to the Battery Charger. Contact Head Rush Technologies for a replacement Battery Charger and Battery Pack.

The Battery Charger will become slightly warm to the touch while charging. This is normal and does not indicate a problem.

The Battery Charger features an LED that indicates the charge status. The LED is Red when the Battery Pack is charging. When charging is complete, the LED will turn Green.

9.7 Catch-and-Hold Mode

The TRUBLUE iQ+ Auto Belay is equipped with a Catch-and-Hold Mode that allows a climber to “work” a route in a similar fashion as they would with a belay partner. With the TRUBLUE iQ+ Catch-and-Hold Mode activated, if a climber falls while climbing, the TRUBLUE iQ+ Auto Belay will sense the fall and engage a secondary friction brake to hold the position of the climber on the wall. The climber’s position will be held for a Preset Hold Time (discussed in section 9.6.4 – Setting the Preset Hold Time). If the Preset Hold Time has not expired, and the user begins to show upward progress, the secondary friction brake will disengage. If the climber falls a second time, the TRUBLUE iQ+ Auto Belay will sense the fall and engage the secondary friction brake to hold the position of the climber on the wall. This series can be repeated as many times as necessary until the climber reaches the top of the wall. At any time, if the climber does not wish to continue climbing, they can descend by allowing the Preset Hold Time to expire. If the climber reaches the top of the wall, a Summit Button located at the top of the climbing route will disengage the secondary friction brake and the primary magnetic braking system will safely lower the climber to the ground.



NOTE

The secondary friction brake system is independent from the patented magnetic brake system. The patented magnetic brake system is the primary braking system and cannot be disconnected.

9.7.1 ACTIVATING CATCH-AND-HOLD MODE

To activate Catch-and-Hold Mode, touch the Base Button.

- The Base Button is a touch-activated switch. Touching any portion of the aluminum bezel will activate the switch.



- The LEDs will pulse Blue to indicate that Catch-and-Hold Mode has been activated
 - For detailed LED function, refer to section 9.7.5 – LED Function

Catch-and-Hold Mode will remain active as long as upward progress is detected by the device.

If no upward progress is detected after 40 seconds, Catch-and-Hold Mode will de-activate as a battery saving measure.

9.7.2 USING CATCH-AND-HOLD MODE

Once activated, Catch-and-Hold Mode requires no special or unique actions to use the functionality. Simply climb as you would normally climb with an Auto Belay. The Auto Belay will monitor your climbing progress. If you fall, the Auto Belay will sense your fall and automatically engage the secondary friction brake to arrest your fall.

Once your fall has been arrested, the secondary friction brake will hold you in that position for a preset amount of time.

- See section “9.7.4 - Setting the Preset Hold Time” to adjust the Preset Hold Time interval

While the secondary friction brake is engaged, if you begin to climb and show upward movement, the secondary friction brake will disengage, and the Auto Belay will continue to monitor your climbing progress.

If you should fall a second time during your climb, the Auto Belay will, again, sense your fall and automatically engage the secondary friction brake to arrest your fall.

You may continue in this manner, Fall→Secondary friction brake engages→Climb Upward→Secondary friction brake disengages→Fall→Secondary friction brake engages→Climb Upward→Secondary friction brake disengages→etc..., as many times as are necessary for you to complete the climb or for you to become too tired to continue climbing.

9.7.3 DEACTIVATING CATCH-AND-HOLD MODE

There are two ways to de-activate Catch-and-Hold Mode

1. Touch the Summit Button at the top of the climbing route



NOTE

The Base Button at the bottom of the route can also be used to de-activate Catch-and-Hold Mode in the case of a user in distress.

2. Let go of the wall, the Auto Belay will sense a fall and engage the secondary friction brake. Wait for the Preset Hold Time to expire. When the Preset Hold Time expires, the secondary friction brake will disengage, and Catch-and-Hold Mode will be de-activated.

9.7.4 SETTING THE PRESET HOLD TIME

The TRUBLUE iQ+ Auto Belay ships with the Preset Hold Time set at 20 seconds. If you wish to change the Preset Hold Time follow the steps below

- Touch and hold the Base Button for 5 seconds.
- After 5 seconds the LEDs will flash White to indicate the preset hold time. Continue holding the Base Button until the desired number of flashes is reached, then release the Base Button to select the Preset Hold Time. The table below shows the relationship between the number of flashes and the Preset Hold Time.

Number of LED Flashes	Preset Hold Time (seconds)
2	20
3	30
1	15

The Preset Hold Time will be retained in the memory of the device even if the Battery Pack is disconnected.

The Preset Hold Time can be changed at any time that a charged Battery Pack is connected.

9.7.5 LED BUTTON

The TBIQ+ Base Button and Summit Button are equipped with LEDs. These LEDs communicate the mode of the device as well as the battery level.



TBIQ+ Base Button with Blue LEDs lit



TBIQ+ Summit Button with Blue LEDs lit

TBIQ+ Modes:

Mode	Description	LED Indicator
System Check	Every time the Battery Pack is connected, the device will perform a system check. The LEDs will flash displaying the system status.	LEDs flash Green – System Check OK LEDs flash Yellow – Battery Level Low LEDs flash Red – Battery Level Critically Low – Catch-and-Hold Mode is unavailable LEDs do not flash - System Error - Refer to Section 10.9 Troubleshooting
Normal Mode	Device functions as a standard TRUBLEUE iQ Auto Belay. A fall during climbing will safely lower the climber to the ground.	LEDs off
Catch-and-Hold Mode	Device will monitor climbing progress and engage the secondary friction brake if a fall is detected.	Blue LEDs pulsing slowly
Hold Mode	Device has sensed a fall, secondary friction brake is engaged, and a climber is being held in position on the wall.	Blue LEDs solid, if upward progress is detected, device will revert back to Catch-and-Hold Mode.
Countdown Mode	Hold Mode engaged, Preset Hold Time is about to expire.	Blue LED flashing

Low Battery Mode	The battery capacity is low. If engaged, Catch-and-Hold mode will function as normal. Replace/recharge the Battery Pack.	LEDs pulse Yellow when Catch-and-Hold Mode is activated.
Critically Low Battery Mode	The battery capacity is critically low. Catch-and-Hold mode will not activate. Replace/recharge the Battery Pack.	LEDs flash Red when attempting to activate Catch-and-Hold Mode. Catch-and-Hold Mode does not activate.
Disco Mode	If the device is left unused for 5 minutes, Disco Mode activates and continues for 5 seconds.	LEDs flash a variety of colors to entice nearby climbers.

9.8 Low Battery Mode

The TRUBLUE iQ+ Auto Belay constantly monitors the Battery Pack charge level. When the Battery Pack capacity is low, the LEDs will pulse Yellow in Catch-and-Hold Mode.

Catch-and-Hold Mode will function as normal if the LEDs are pulsing Yellow

- Catch-and-Hold Mode may not function properly for prolonged use in Low Battery Mode. Catch distance may increase or cease to function if the Battery Pack capacity is too low.

The LEDs will pulse Yellow in Catch-and-Hold Mode until a recharged Battery Pack is connected.

9.9 Critically Low Battery Mode

When the Battery Pack capacity is too low to sufficiently engage the secondary friction brake, the LEDs will flash Red when Catch-and-Hold Mode is activated.

- Catch-and-Hold Mode will not turn on and the LEDs will turn off
- The Auto Belay will still function as a normal Auto Belay but Catch-and-Hold Mode will not be available until a charged Battery Pack is connected.

10.0 INSPECTION & MAINTENANCE

10.1 Annual Recertification



DO NOT OPERATE AFTER THE DATE SHOWN ON THE CERTIFICATION LABEL

Operation of a TRUBLUE iQ+ Auto Belay without a current Certification Label visible is strictly forbidden. Severe bodily injury or death could occur.



NOTE

Only the TRUBLUE iQ+ Auto Belay needs to be sent for annual recertification. There is no need to send in the Summit Button, Base Button, Battery Pack, or any of the cables.

The TRUBLUE iQ+ Auto Belay requires an annual recertification to be carried out by an authorized Head Rush Technologies service agent.

The Certification expiration date is shown on the Certification Label located on the side of the housing. Dismount the Auto Belay and return to an Authorized Service Center prior to the expiration date.

Do not use the Auto Belay after date shown here.

10.2 Scheduled Maintenance

The following inspection and service actions must be carried out by the Operator or Operator-trained Staff. All personnel performing these actions must be trained in the correct procedures and deemed competent to do so.



NO UNAUTHORIZED SERVICING

Do not attempt to carry out any maintenance, repair or service actions not detailed in the Operator Manual.

Any unauthorized maintenance, repair or modifications to the Auto Belay will compromise safety, render the unit not fit for use, and void the Warranty provisions.



NOTE

Service in a clean environment. If the Auto Belay has been removed from its operational location for service, ensure that the service area is clean and free from contaminants.

Ensure unit is securely placed on a sturdy work table and that side covers are not subject to damage.

10.2.1 SAFETY PRECAUTIONS



HEAVY OBJECT – TBiQ+LT: 19.2kg (42.3lbs) TBiQ+XL: 22.0kg (48.5lbs)

Ensure the Auto Belay device is secured during service to prevent accidental damage or injury from dropping.



CAUTION – SPRING LOADED PARTS

The webbing assembly is spring loaded and will rapidly return into the device if released. This may result in damage or injury.



MAGNETIC PARTS

The Auto Belay contains strong magnets. Always ensure working environment is free of loose ferrous materials. Ingress of metal objects may compromise Auto Belay operation. The TRUBLUE iQ+ Auto Belay conforms to all standards regarding magnetic health safety of magnetic flux power next to the device with the plastic side covers installed. This limit has been established as safe for medical devices on and in the human body.

10.3 Daily Inspection

The daily webbing inspection must include at least a visual inspection sufficient to evaluate the wear and integrity of the device's webbing. Please see "Webbing Wear" below for a detailed description of when a webbing should be taken out of service. The inspection may be performed while the unit is mounted if the webbing can be adequately inspected.

10.4 Weekly Inspection

The TRUBLUE iQ+ Auto Belay must be inspected weekly for correct operation and overall condition. The weekly inspection may be carried out with the unit in place or removed to a sturdy work table. The weekly inspection and the 6 month inspection must be recorded in the inspection log at the back of this Manual.

10.4.1 INSPECTION PROCEDURE

Ensure adequate lighting and unrestricted access is available to permit a thorough inspection of all areas of the Auto Belay. This inspection should be completed either with the Auto Belay dismounted or by climbing to the location of the Auto Belay and anchoring in, so you may visually inspect the unit and the entire length of webbing.

1. Clean any dust, dirt or contamination off the casing and fittings with a clean cloth.



DO NOT USE SOLVENTS OR ABRASIVES

Clean with a cloth only. Do not use any cleaners, solvents or abrasives on any part of the Auto Belay or its associated equipment. Contact Head Rush Technologies for any questions regarding disinfecting the Auto Belay or the webbing components.

2. Visually inspect the casing, mounting holes, plastic mounting insert, and plastic covers for wear, impact damage, cracking, deformation, and corrosion. Replace any damaged items or remove the Auto Belay from service.
3. Check all safety labels are in place and in good condition.
4. Check that the date on Certification Label is current.
5. Inspect the condition of the connector, checking for:
 - Wear and damage that could affect the strength of the connector.
 - Correct operation of the locking mechanism.
 - Smooth operation of the swivel.

If the connector or swivel does not automatically lock or rotate, the connector can be washed with soap and water and allowed to air dry. Then lubricate per the connector Manufacturer's recommendations, which include a dry, wax-based or PTFE-based lubricant, until fully operational. If full functionality cannot be restored, replace the entire webbing assembly.

6. Slowly pull out the entire length of webbing from the unit. As webbing is withdrawn, inspect for:

- Damage, cuts, or abrasion to stitching.
- Cutting, wear, and abrasion to the surface of webbing.
- Discoloration, fading on the surface.
- Heat and friction damage such as hard or shiny areas.
- Contamination from dirt or chemicals.
- Twisting or knotting.

Replace webbing if any signs of wear or damage are present that resemble the replacement criteria photos.

7. Allow the webbing to slowly retract into the unit – checking the retraction action is strong and smooth. Sharply tug at the webbing every 1-2 meters, to cinch down the webbing stack.
8. Complete and file 'Weekly Inspection Log' documentation.
9. Return the Auto Belay device to service.

10.4.2 WEBBING WEAR



INSPECT WEBBING DAILY

Webbing in your TRUBLUE iQ+ Auto Belay must be evaluated on a daily basis. A detailed description of when a webbing should be taken out of service is included in the Wear Tables below. Webbing **MUST** be taken out of service by the time the webbing resembles the stage of wear designated in the Wear Tables, or after 1.5 years of usage, whichever occurs first. The date of manufacture of the webbing is located on the webbing tag inside the device near the shackle. The date of manufacture of the webbing **MUST** be recorded in the inspection log. Continued use of webbing with wear at or beyond the designated stage of wear below could result in serious injury or death.

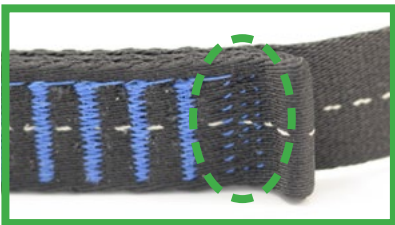











The structural stitch pattern includes a sacrificial bumper stitch pattern which protects the structural bar tack stitches. See highlighted section for bumper stitches. These stitches are allowed to unravel over time due to impacts with the Nozzle. Trim any loose threads in this section. When this section is completely unraveled over time, the entire webbing assembly must be replaced.

WEAR TABLES

Webbing pictures outlined in **red** in the tables below show webbing that **MUST** be taken out of service and replaced immediately to continue using your TRUBLUE iQ+ Auto Belay.

TRUBLUE iQ+ Auto Belay

Edge and Face Wear		Progress of Bumper Stitch Separation	
Edge Wear Monitor		Monitor	
Edge Wear Monitor		Monitor	
Face Wear Replace		Monitor	
Edge Wear Replace		Monitor	
Edge Wear Replace		Replace	

MOLDY WEBBING

Any webbing showing signs of mold should be taken out of service.

UV EXPOSURE

Webbing used outdoors in direct sunlight for extended periods of time should be replaced more frequently. Recommend at least every 6 months.

TROUBLESHOOTING WEBBING WEAR

Symptoms	Potential Causes	Potential Solutions
BUMPER STITCH DEPLOYED	Unit mounted low	Mount the unit higher or develop routes that minimize the impact of the bumper stitch on the Nozzle at the finish of the climb.
	Normal use of the TRUBLUE iQ+ Auto Belay	The bumper stitch is designed to absorb impacts with the Nozzle. Over time, these impacts will bend the webbing and slowly pull out the stitches. Trim any loose threads. If the bumper stitch is completely unraveled, the webbing assembly must be replaced.
WEBBING FACE WEAR	Webbing is rubbing on the wall (overhang or corner of wall)	Move the TRUBLUE iQ+ Auto Belay so the webbing does not rub on the wall/corner.
	SIDE WEAR Webbing is rubbing on a hold	Look for problem holds. Move the hold. Do not place large holds immediately below TRUBLUE iQ+ Auto Belay.
LOOP FAILURE & HAND GRIP WEAR	Foreign objects, including dirt and/or dust have introduced damage to webbing assembly	Make sure to cover the TRUBLUE iQ+ Auto Belay when not in use. Wipe the webbing with a dry cloth daily, after use.
	Normal use of TRUBLUE iQ+ Auto Belay	Parts and webbing wear over time with normal operation, replace webbing as necessary.
BAR TACK DAMAGED	Climbers are rubbing the bartack on holds or the wall	Monitor routes with the TRUBLUE iQ+ Auto Belay to minimize contact with holds or wall features while climbing.
UV FADED WEBBING or HAND GRIP	Sun is damaging webbing	Remove TRUBLUE iQ+ Auto Belay at the end of day or cover unit and webbing after use. Allow webbing to retract into the device when not in use.
	Normal use of TRUBLUE iQ+ Auto Belay in outside applications	Webbing in outdoor installations is subjected to UV and other environmental factors. This webbing will wear out faster, or in cases of light use might not show typical wear patterns. Replace webbing more frequently in these environments.
HAND GRIP WEAR	Hand grip is rubbing against wall/holds	Look for problem holds. Move the hold.
	Normal use of TRUBLUE iQ+ Auto Belay	Parts and webbing wear over time with normal operation, replace webbing as necessary.
WEBBING IS MOLDY/ DISCOLORED	Webbing is not being dried after being used in wet conditions	Whenever using the TRUBLUE iQ+ Auto Belay in wet conditions, take the unit down at the end of the day, extend the webbing in a sanitary environment, and allow webbing to dry outside of the unit.

10.5 Six Month Inspection

The TRUBLUE iQ+ Auto Belay requires an in-depth six (6) month inspection by the Owner/Operator. For the six month inspections the unit must be dismantled and removed to a sturdy work table.

10.5.1 INSPECTION PROCEDURE

1. Dismount the Auto Belay (refer to Installation Instructions).
2. Clean Auto Belay using a clean cloth.
3. Carry out Steps 1 through 6 of the 'Weekly Inspection'.
4. Remove the Nozzle – Refer to **"To remove the Nozzle assembly"** section below.
5. Inspect Nozzle Assembly for the following:
 - Excessive wear to slot, which could affect retraction of the webbing.
 - Splitting, cracking and deformation.
 - Correct fit in housing.

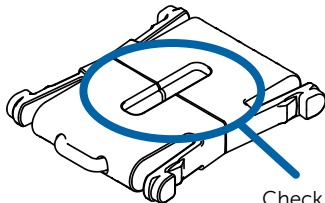

Nozzle Wear

Check Nozzle for excessive wear around slot

10.5.2 WEBBING INSPECTION

1. With Nozzle assembly removed, pull out the complete webbing line, including approx. 150 mm (6 in) of the short webbing loop.
 - Twist the webbing 90 degrees, then place a suitable pin through the loop in the short webbing loop, above the joining link to prevent it retracting back into the unit.
2. Inspect the webbing line by passing the webbing slowly through your hands under a good light. Inspect the webbing for:
 - Damage to stitching (cuts or abrasion).
 - Cuts to webbing, especially to edges.
 - Abrasion across the surface of the webbing, wear and fraying, especially to the edges.

- UV degradation – although difficult to detect, visual indications are discoloration, and fading of the webbing surface. The webbing will also become very soft. Consider replacement.
- Chemical attack, this can result in soft or weak fibers, color change or flaking of the surface.
- Heat or friction damage, indicated by hard fibers or glazing of the surface.
- Contamination from dirt, grit, sand, or rust.
- Twisting, knotting, or permanent deformation of webbing.

Replace the webbing if any signs of damage or deterioration are present.

3. Inspect the webbing joining shackle. Ensuring that:

- The shackle pin is secure and straight – do not attempt to tighten or loosen.



NOTE

The shackle pin is secured with thread locking compound and any attempt to turn will compromise its security.

- The shackle is undamaged and in the correct orientation.
- The webbing around the link is not worn or damaged.



Webbing Retaining Pin

4. Remove the pin, untwist the webbing 90 degrees, and allow the upper line to slowly retract into the unit. Inspect the webbing as it retracts and ensure that the webbing line does not twist.
5. Refit the Nozzle assembly – Refer to **“To refit the Nozzle assembly”** section.
6. Complete the “Six Month Inspection” documentation.
7. Return Auto Belay to service.

10.6 Nozzle Replacement

If the Nozzle assembly shows signs of excessive wear that could impede retraction of the webbing, damage, or poor fit it must be replaced.



USE ONLY GENUINE TRUBLUE iQ+ REPLACEMENT PARTS



ALWAYS REPLACE NOZZLE AS A PAIR

If Nozzle requires replacement, always replace as a matched pair – do not mix worn and new Nozzle pieces.

To remove the Nozzle assembly:

1. Place the Auto Belay unit with the flat plastic cover side down taking care not to damage the plastic side covers - Ensure it is secure and cannot fall.
2. Pull out the Nozzle Pin.
3. Pull out all the webbing. The short webbing assembly will push the two Nozzle halves open. Twist the webbing 90 degrees and pin the webbing.
4. Slightly twist each Nozzle Half to release from the housing tab slot.



Assembled Nozzle

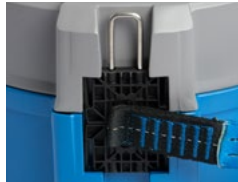

Step 2 - Remove pin



Step 3 - Pull out webbing



Step 4 - Pin Short Webbing Assembly

Refit the Nozzle assembly:

1. Refit the upper half of the Nozzle assembly into the recess on the casing.
2. Fit the lower half of the Nozzle assembly.
3. Remove the pin and untwist the webbing 90 degrees. Allow the webbing to slowly retract, and push the two Nozzle halves closed. Retract the webbing back into the device, tugging on the webbing every 1-2 meters to properly seat the webbing.
4. Replace the pin through both Nozzle halves.
5. Check Auto Belay for correct operation.

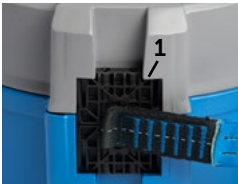

Step 1 – Fit top half

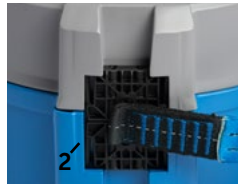

Step 2 – Fit bottom half



Step 3 – Fit pin

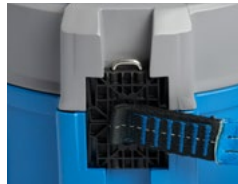

Assembled Nozzle

10.7 Webbing Line Replacement

If the webbing line shows signs of wear, damage, or contamination then it will need to be replaced. The short webbing loop inside the device does not receive wear under normal operation and is not inspectable by the Operator. Replace Line as follows:

10.7.1 SAFETY PRECAUTIONS



DO NOT ALLOW SHORT WEBBING LOOP TO RETRACT INTO HOUSING

With Nozzle removed take care to not permit uncontrolled retraction of short webbing loop into unit. Uncontrolled retraction will result in internal damage and require repair by the Manufacturer.



USE ONLY GENUINE TRUBLUE iQ+ REPLACEMENT PARTS

The TBiQ+LT must use the TRUBLUE iQ 12.5M webbing. There is a blue tag near the Handgrip with "12.5M". The TBiQ+XL must use the TRUBLUE iQ 20.0M webbing. There is a purple tag near the Handgrip with "20M".

10.7.2 WEBBING LINE REPLACEMENT PROCEDURE

To replace the webbing line:

1. Remove the Auto Belay from service.
2. Remove the Nozzle assembly – Refer **"To Remove Nozzle Assembly"** above.
3. While holding Auto Belay securely, pull out the webbing line until the end of the short webbing loop and the joining shackle are exposed.
4. Locate the loop in the short webbing loop, approx. 150 mm (6 in) past the shackle. Twist webbing 90 degrees and place the Nozzle Assembly pin through the loop in the short webbing loop to prevent it retracting back inside the casing.

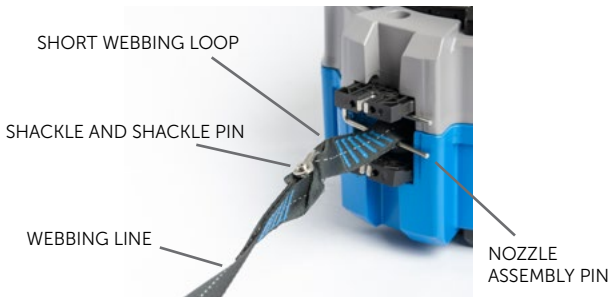

Webbing joining link parts

5. Unscrew the shackle pin and discard.
6. Remove webbing and shackle pin from the short webbing loop.
7. Ensure the loop part of the shackle is fitted to the short webbing loop.



THREAD LOCKING COMPOUND

Ensure the factory applied thread locking compound is present on the shackle pin threads. Do not reuse the Shackle Pin.



WARNING

The TRUBLUE iQ+ Auto Belay can only use TRUBLUE iQ+ webbing. Do not use original TRUBLUE webbing, or any webbing from any other manufacture. Incompatible webbing may result in severe injury or death if used. The TRUBLUE iQ+ webbing is the same as the TRUBLUE iQ webbing, has a white yarn down the center, and is sold only by authorized Head Rush Technologies locations.



- Fit the new webbing line, passing the included new shackle pin through the loop as shown below.

Hand Tight



Correct shackle fit

- Tighten the shackle pin to hand tight, ensuring the threads are fully engaged and the end of the pin is flush with the joining shackle as shown.
- Remove the holding pin, untwist the webbing 90 degrees, and allow the new line to slowly retract until short webbing loop and joining link is inside casing. Ensuring that the webbing line does not twist.



Once shackle pin is tightened, it must not be loosened or re-tightened. This will break the locking compound and the shackle pin may become loose. The shackle pin must be replaced if this happens.



Ensure that the webbing line feeds squarely and without twists when retracting back into the Auto Belay.

Failure to do so may result in equipment failure, serious injury or death to participants.

11. Refit Nozzle assembly – Refer to **“Refit the Nozzle assembly”** section above.
12. Slowly retract the webbing line into the casing, checking the action is smooth and adequate spring resistance is felt. Sharply tug on the webbing every 1-2m to cinch down the webbing onto the stack.
13. Once line is fully retracted, pull out line a short distance using reasonable force and allow it to retract. Repeat two to three times to ensure line is firmly wound onto the drum.
14. Return Auto Belay to service and check for correct retraction and descent.

10.8 Replacement Parts

Your TRUBLUE iQ+ Auto Belay is fitted with a number of replaceable parts that may be refitted without the need to return the device to an authorized Head Rush Technologies service agent. Always follow the Manufacturer’s instructions as detailed in this Operator Manual and any Part Replacement Guide supplied when undertaking replacement of a part.

TRUBLUE iQ+ Auto Belay Replaceable Components

Part Number	Name
12790	TRUBLUE iQ+ Replacement Webbing, 12.5m, TRU-Lock Aluminum carabiner
12791	TRUBLUE iQ+ Replacement Webbing, 12.5m, Adventure webbing
12792	TRUBLUE iQ+ Replacement Webbing, 12.5m, Open Loop (no connector)
12793	TRUBLUE iQ+ Replacement Webbing, 20m, TRU-Lock Aluminum carabiner
12794	TRUBLUE iQ+ Replacement Webbing, 20m, Adventure webbing
12795	TRUBLUE iQ+ Replacement Webbing, 20m, Open Loop
12796	TRUBLUE iQ+ Replacement Webbing, 12.5m, Steel Swivel Carabiner
12797	TRUBLUE iQ+ Replacement Webbing, 20m, Steel Swivel Carabiner
12755	TRUBLUE iQ+ Replacement Mounting Insert
12742	TRUBLUE iQ+ Replacement Front Cover
12511	TRUBLUE iQ+ Replacement Back Cover
12813	TRUBLUE iQ+ Replacement Nozzle Assembly
12604	TRUBLUE iQ+ Replacement Shipping Box
12605	TRUBLUE iQ+ Replacement Shipping Box Insert
12609	TRUBLUE iQ+ Replacement Shipping Box Insert - Top
12563	TRUBLUE iQ+ 20 m Drop Cable
12566	TRUBLUE iQ+ Y-Cable
12557	TRUBLUE iQ+ Battery Charger
12588	TRUBLUE iQ+ Battery Pack Subassembly
12575	TRUBLUE iQ+ Cable Tie Base
12580	TRUBLUE iQ+ Base Button Subassembly
12581	TRUBLUE iQ+ Summit Button Subassembly
12547	TRUBLUE iQ+ Backing Pad – Base Button
12877	TRUBLUE iQ+ Backing Pad – Summit Button





NOTE

For optimal performance of your TRUBLUE iQ+ Auto Belay, only use genuine TRUBLUE iQ+ parts and accessories.

To order replacement parts or accessories, contact your authorized Head Rush Technologies service agent or go to www.headrushtech.com.

10.9 Troubleshooting

Refer to troubleshooting instructions or contact your authorized Head Rush Technologies service agent.

Problem	Solution
<p>No LEDs light when the Base Button switch is touched</p>	<p>Ensure Battery Pack is properly connected</p> <p>Ensure Battery Pack is charged</p> <p>In some cases, you may need to hold your hand on the Base Button switch for up to 1 second for the switch to sense a touch</p> <p>Ensure the switch is being touched with bare skin. The capacitive switch may not work through gloves or tape.</p> <p>Ensure all cables are fully and securely connected</p> <hr/> <p> NOTE Disconnect the Battery Pack before connecting or disconnecting any cables</p>
<p>The TRUBLUE iQ+ Auto Belay does not catch and hold</p>	<p>Ensure Catch-and-Hold Mode is activated by touching the Base Button</p> <ul style="list-style-type: none"> ▪ Catch-and-Hold Mode is activated when the LEDs are pulsing Blue <p>Ensure the Battery Pack is properly connected</p> <p>Ensure the Battery Pack is charged</p> <p>Ensure all cables are fully and securely connected</p> <hr/> <p> NOTE Disconnect the Battery Pack before connecting or disconnecting any cables</p>
<p>LEDs do not light when the Battery Pack is connected</p>	<p>Ensure the Battery Pack is charged</p> <p>Ensure all cables are fully and securely connected</p>
<p>Summit Button LEDs do not light</p>	<p>Ensure all cables are fully and securely connected</p> <hr/> <p> NOTE Disconnect the Battery Pack before connecting or disconnecting any cables</p>

Touching Summit Button does not exit Catch-and-Hold Mode

In some cases, you may need to hold your hand on the Summit Button for up to 1 second for the switch to sense a touch.

Ensure the Summit Button is being touched with bare skin. The capacitive switch may not work through gloves or tape.

Ensure all cables are fully and securely connected



NOTE

Disconnect the Battery Pack before connecting or disconnecting any cables

10.10 Transportation

To ensure safe shipment of your Auto Belay, it should only be shipped in authorized TRUBLUE iQ+ packaging (box and packing material). If you have misplaced your original packaging, purchase replacement packaging from an authorized Head Rush Technologies service agent, or online at www.headrushtech.com. You will be responsible for the cost of any damage and necessary repairs due to shipping your Auto Belay in unauthorized packaging.



CARE FOR THE ENVIRONMENT

Reuse the original packaging when shipping the Auto Belay.

11.0 MANUFACTURER'S DETAILS

For Recertification or unscheduled service or repairs, return your TRUBLUE iQ+ Auto Belay to your nearest Head Rush Technologies Authorized Service Center or to the Manufacturer at the address shown below.

ADDRESS

Head Rush Technologies
1699 Cherry Street, Suite C
Louisville, CO 80027
USA

CONTACT DETAILS

+1-720-565-6885
www.headrushtech.com
info@headrushtech.com

To find a Service Center outside the U.S., visit www.headrushtech.com/find-a-distributor.

EU importers may apply their name and address on the device to comply with government regulations next to the specification label.

12.0 INSPECTION LOGS

12.1 Weekly Inspection Log

INSPECTION REMINDER: A webbing inspection must be performed daily and must include at least a visual inspection sufficient to evaluate the wear and integrity of the device's webbing. The inspection may be performed from the ground if the webbing can be adequately inspected. Replace webbing if any signs of wear or damage are present. Webbing must be replaced every 1.5 years. Webbing wear documents are available at www.headrushtech.com. Replacement webbing can be ordered from your dealer or at www.headrushtech.com. A year from your purchase date the unit is due for recertification, which should be scheduled with an authorized service center.

This guide is provided for your convenience in keeping track of your weekly unit inspections. Operator Manuals and additional copies of the Weekly Inspection Log can be found at the following links:

Manuals:

www.headrushtech.com/product-manuals

Webbing inspection:

www.headrushtech.com/webbing-inspection

Webbing logs:

www.headrushtech.com/webbing-logs

Model#

Serial #

Webbing Date of Manufacture:

Webbing Replacement Date (DOM + 1.5yrs):

WEEKLY INSPECTION

1. Visually inspect casing, mounting holes, and covers for wear, impact damage, cracking, deformation, or corrosion. Replace damaged items or remove from service.

	JAN	FEB	MAR	APR	MAY	JUN	JUL	AUG	SEP	OCT	NOV	DEC
Week 1												
Week 2												
Week 3												
Week 4												

2. Check all safety labels are in place and in good condition. Check that the date on certification label is current.

	JAN	FEB	MAR	APR	MAY	JUN	JUL	AUG	SEP	OCT	NOV	DEC
Week 1												
Week 2												
Week 3												
Week 4												

3. Check the condition of the connector for wear and damage, correct operation of the locking mechanism, and smooth operation of the connector swivel.

	JAN	FEB	MAR	APR	MAY	JUN	JUL	AUG	SEP	OCT	NOV	DEC
Week 1												
Week 2												
Week 3												
Week 4												

4. Slowly pull webbing from unit. Inspect for damage to stitching, cuts, wear, fraying, discoloration, and other signs of damage or contamination. Allow the webbing to slowly retract into casing, check that the retraction action is strong and smooth.

	JAN	FEB	MAR	APR	MAY	JUN	JUL	AUG	SEP	OCT	NOV	DEC
Week 1												
Week 2												
Week 3												
Week 4												

DO NOT USE THE DEVICE IF IT SHOWS ANY SIGNS OF DAMAGE, WEAR, OR INCORRECT OPERATION. If any signs of damage, wear, or incorrect function exist, remove the device from duty and contact an authorized service center for servicing options.

12.2 Six Month Inspection Log

This guide is provided for your convenience in keeping track of your bi-annual (every 6 months) unit inspections. **Refer to the Operator Manual for in-depth instruction on how to perform outlined tasks.** The Operator Manual and additional copies of the Six Month Inspection Log can be found at www.headrushtech.com/webbing-logs.

Model #:		Serial #:		
Inspector:		Inspection Date:		
Webbing Assembly Date of Manufacture:				
ORDER/DESCRIPTION		PASS	FAIL	COMMENTS
1	Dismount the unit (Refer to "Installation" section of Manual)			
2	Carry out 'Weekly Inspection'.			
3	Remove the Nozzle – Refer to 'Nozzle Removal' section of Manual.			
4	Inspect Nozzle Assembly for: <ul style="list-style-type: none"> ▪ Excessive wear to slot. ▪ Splitting, cracking and deformation around slot and mounting flanges. ▪ Correct fitment in housing. 			
5	With Nozzle assembly removed, pull out the complete webbing line, including approx. 150 mm (6 in) of the short webbing loop.			
6	Twist the webbing 90 degrees and place a suitable pin through the loop in the short webbing loop, above the joining link to prevent it retracting back into the unit.			
7	Inspect the complete webbing line for: <ul style="list-style-type: none"> ▪ Damage to stitching. ▪ Cut, wear, and fraying. ▪ Discoloration and contamination. ▪ Any other signs of damage. 			

8	<p>Inspect the webbing joining shackle, ensuring that:</p> <ul style="list-style-type: none"> ▪ The shackle pin is secure and straight – do not attempt to tighten. (NOTE - The shackle pin is secured with thread locking compound and any attempt to turn will compromise its security.) ▪ The shackle is undamaged and in the correct orientation. ▪ The webbing around the link is not worn or damaged. 			
9	<p>Remove the pin, untwist the webbing 90 degrees, and allow the webbing to slowly retract into the unit cinching the webbing every 1-2 meters. Inspect the webbing as it retracts. Make sure not to introduce a twist in the webbing as it is retracting.</p>			
10	Refit the Nozzle assembly.			

DO NOT USE THE DEVICE IF IT SHOWS ANY SIGNS OF DAMAGE, WEAR, OR INCORRECT OPERATION. If any signs of damage, wear, or incorrect operation exist, remove the device from duty and contact an authorized service center for servicing options.



TRUBLUE *iQ+*



REGISTER YOUR DEVICE

Get automatic updates on recertification and product information –
visit www.headrushtech.com/register

ANNUAL RECERTIFICATION IS REQUIRED

Please keep the shipping box for your device. For instructions on annual
recertification, visit www.headrushtech.com/annual-service

+1-720-565-6885

www.headrushtech.com

info@headrushtech.com

Jan 2023